

OPERATOR'S MANUAL

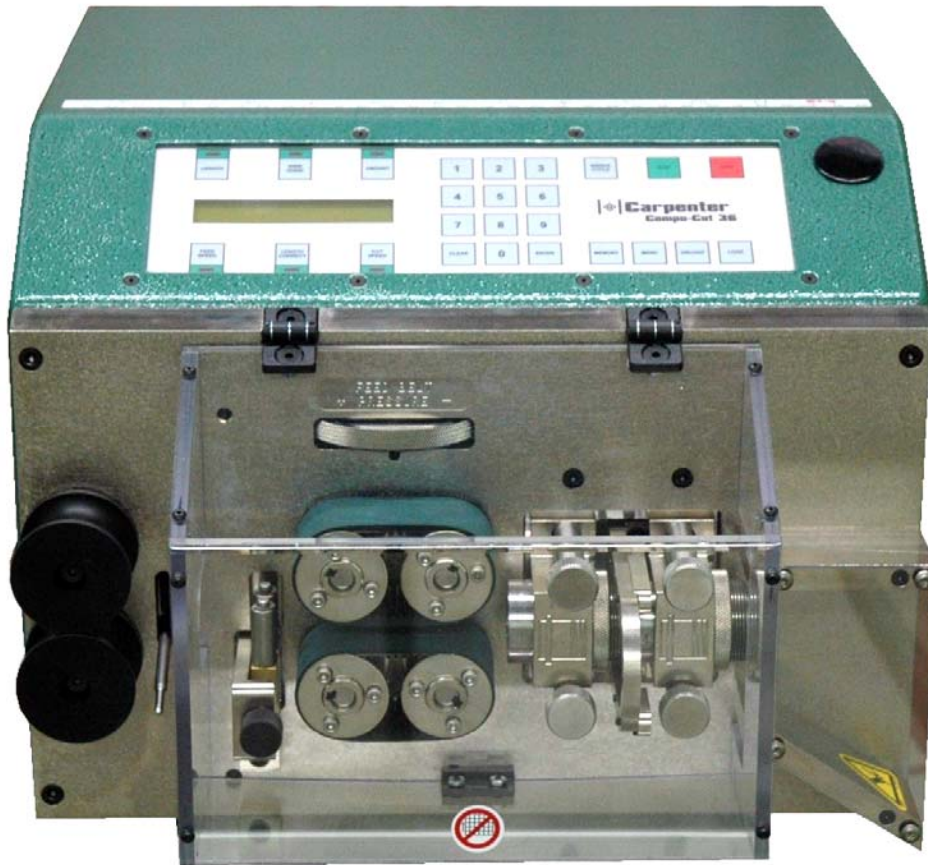

Model 36A Compu-Cut[®] Wire & Tubing Cutter

PRODUCTION WIRE PROCESSING EQUIPMENT

****IMPORTANT****

**THIS MACHINE CONTAINS PNEUMATIC
COMPONENTS.**

**IT IS EXTREMELY IMPORTANT THIS
MACHINE IS CONNECTED TO A
CLEAN, FILTERED AND LUBRICATED
AIR SUPPLY.**

Please refer to Page 21 (Maintenance Procedures) of this manual for specifications regarding the use of an automatic inline oiler.

**CONTAMINATED AIR MAY CAUSE THE
MACHINE TO MALFUNCTION.**

CARPENTER MODEL 36A COMPU-CUT

TABLE OF CONTENTS

Introduction	3-4
Safety Instruction	5
Machine Specifications.....	6
Set Up	7-8
Safety Guarding	7
Machine Set Up.....	7
Input/Output Guide Selection	7
Input/Output Guide Change	7
Loading Material.....	8
Feed Belt Pressure	8
Programming	9-12
LCD Sample Display	9
Length.....	10
Amount / Batching.....	10
Feed Speed.....	10
Single Cycle	11
Length Correction.....	11
Program Storing/Recall	12
Unloading Material	12
Special Features	13-16
Kitting.....	13-15
Programming	13-14
Kit Storing	14
Kit Recall.....	15
Unit of Measure.....	15
Password	16
Material Sensor	16
Optional Features.....	17-19
Wire Marker	17-18
Wire Stacker	19
Maintenance Procedures.....	20-21
Belt Change	20
Blade Change	20
Machine Lubrication	21
Trouble Shooting.....	22
Recommended Spare Parts	23
Optional Equipment.....	23
Warranty	24

CARPENTER MODEL 36A COMPU-CUT

INTRODUCTION

Thank you for choosing Carpenter Mfg. Co. Inc. Wire Processing Equipment.
For over 50 years Carpenter has been a leader in
Wire Processing Technology and Service.
Our desire has always been to bring you reliable products.
We look forward to a long healthy relationship with you and our company.

The Model 36A can process a wide range of cables as referenced on the following page.
These processing specifications are based upon the
most commonly manufactured cables.
Special applications may arise with cables that are
within the specification limits of the machine but are very difficult
or unsuccessful to process.
Likewise, cables that exceed the specified limits
of the machine can sometimes be processed.
Because there are many variables involved in Wire Processing
we strongly recommend a free Wire Evaluation at our factory
followed by a demonstration from a Carpenter representative
to insure the ultimate success of your Wire Processing Application.

This operating manual explains how to operate
the Model 36A as well as some troubleshooting tips.
To ensure the best performance of your machine,
read this manual carefully until you familiarize yourself
thoroughly with its operation and features.
After you have read through the manual, keep it available for reference.

Use this manual as a quick and handy reference
tool for clarifying any questions that may arise.
If you have any questions about this
machine or service please let us know.
Our phone number is 315.682.9176, fax number 315.682.9160.

Carefully unpack the Carpenter Model 36A.
We recommend that you keep the original box and packaging
as it will protect the machine for future transportation if necessary.

CARPENTER MODEL 36A COMPU-CUT

IMPORTANT NOTICE

The products in this shipment left our facility in good working condition.

Their safe delivery is the responsibility of the carrier that delivered this shipment to you.

Our stated shipping terms are F.O.B. our facility at 110 Fairgrounds Drive, Manlius, NY 13104.

According to applicable laws, the responsibility for this shipment was transferred to you as soon as the carrier accepted the goods at our warehouse.

If concealed damage is discovered after unpacking this shipment, you must submit a damaged freight claim with the carrier.

Carpenter Mfg. Co., Inc. cannot submit your claim for you.

In order for you to collect for concealed damage, the carrier must be notified with 5 days of the date you receive this shipment.

You must leave the damaged items and packing material as is (i.e. return all merchandise and all packing material to the shipping container) until the claim has been inspected by the carrier.

Also, the carrier will not accept a claim if the goods have been moved from the point of the carriers delivery to another street address.

If you have any questions or problems, please give us a call at (315) 682-9176.

CAUTION

This equipment comes equipped with a LEXAN safety guard, containing a safety interlock switch. The machine will not operate unless the guard is in the closed position.

****IMPORTANT****

Do not attempt to defeat the function or purpose of the safety interlock switch. Serious injury to the operators' eyes, fingers or other body parts may result from attempts to operate this equipment with the safety guard in the raised position.

CARPENTER MODEL 36A COMPU-CUT

****IMPORTANT****

PLEASE READ ENTIRE INSTRUCTIONS BEFORE OPERATING MACHINE

APPLICATIONS

The Model 36A COMPU-CUT is designed to measure and cut small solid wire, stranded wire, multi conductor cable, rigid and flexible plastic tubing.

NOTE: A motorized Prefeed, may be needed depending on application.

SPECIFICATIONS

ELECTRICAL CONNECTION	88-264 VAC, 47-63 Hz Automatic Switching
AIR SUPPLY	80-100 PSI or 5.4-6.2 BAR **CLEAN, FILTERED AND LUBRICATED AIR ONLY**
MAIN FUSES	2 - 5 x 20mm 6.3AMP Fast Action
MAXIMUM CABLE DIAMETER	1.000" (material dependent)
TUBING	1.000" (material dependent)
CUT LENGTH	0.05 through 9,999.99inches or 1.2 through 99,999.9mm(longer lengths obtainable in inches)
QUANTITY	1 to 999,999 pcs.
UNIT OF MEASURE	mm or Inches User selectable
TRANSPORT SPEEDS	5 Programmable
SINGLE PROGRAM MEMORY	500 Programs
KITTING PROGRAM MEMORY	100 Programs
PASSWORD PROTECTION	User Programmable
DIMENSIONS	13.7"W x 11"H x 17"D (including safety guard)
WEIGHT	52 lbs. or 24 kg.

MAXIMUM PRODUCTION RATES

<u>LENGTH</u>	<u>CUT ONLY</u>
1"	6000 pcs./hr.
4"	4980 pcs./hr.
12"	3660 pcs./hr.
24"	2700 pcs./hr.

These are approximate results with an air setting of 80 PSI

CARPENTER MODEL 36A COMPU-CUT

SET-UP

SAFETY GUARDING

The Model 36A comes equipped with a LEXAN guard containing a safety interlock switch. The machine will not run unless the guard is in the closed position ****IMPORTANT** DO NOT ATTEMPT TO DEFEAT THE FUNCTION OR PURPOSE OF THE SAFETY INTERLOCK SWITCH. SERIOUS INJURY TO THE OPERATORS EYES, FINGERS OR OTHER BODY PARTS MAY RESULT FROM ATTEMPTS TO OPERATE THE MODEL 36A WITH THE SAFETY GUARD IN THE RAISED POSITION.**

MACHINE SET UP

Insert air line into the straight connector located on the back panel of the machine. Connect opposite end to air supply. Make certain the air supply is clean and filtered with an attached inline oiler (refer to Page 21 for specifications). The absence of an inline oiler may result in failure of the pneumatic cylinder that operates the Blade Mechanism. Plug the female end of the Power Cord into the Power Entry Module, located on left side of machine. Plug the male end into a proper electrical outlet. Turn on power switch.

INPUT/OUTPUT GUIDE SELECTION

The Model 36A comes installed with 1pc. #6617 Input Guide and 1pc. #6620 Output Guide of your choice. Eight Input/Output Guide sizes are available; sizes range from 1/8" to 1.000" in 1/8" increments. Select the wire guide with the smallest inside diameter that slips freely over the outside diameter of the material to be processed.

INPUT/OUTPUT GUIDE CHANGE



1. Press the **WIRE GUIDE** key. This will pull the Blade in toward the machine and into position for the Guide Change.
2. Remove 2pcs. #6615 Guide Block by loosening and removing 4pcs.#6614 Thumb Screw.
3. Remove each Guide by unscrewing the #6619 Guide Retaining Ring.
4. To reinstall, insert each Guide into each #6615 Guide Block until the shoulder of the Guide sets into the Guide Block. Secure each Guide into place with the Guide Retaining Ring. Refer to the diagram below for proper placement.
5. ****IMPORTANT****Refer to the diagram below for proper positioning when reinstalling the #6615 Guide Blocks. Push each Guide Block up to the blade and secure into place with the four #6614 Thumb Screws.

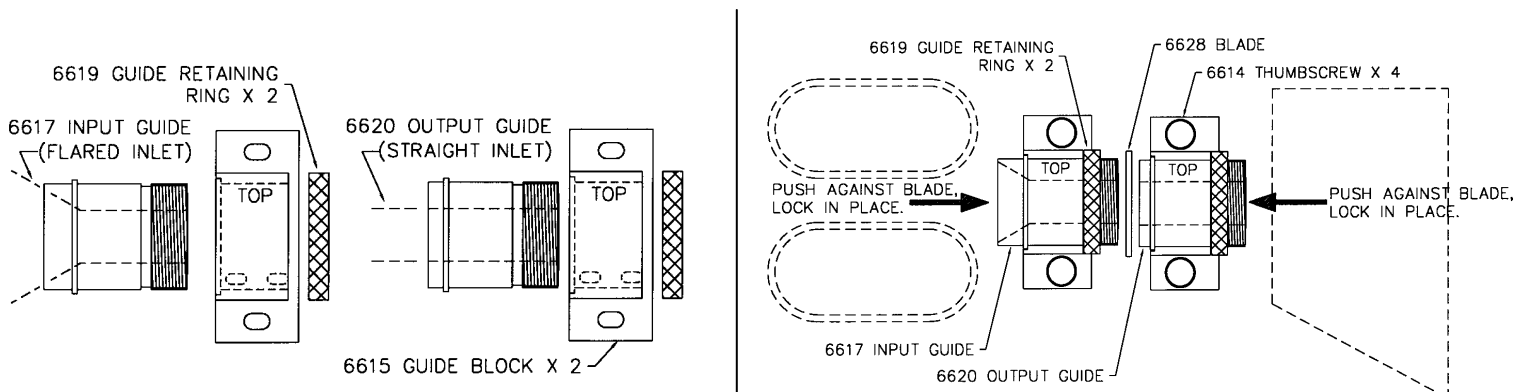

CARPENTER MODEL 36A COMPU-CUT

SET-UP

cont.

LOADING MATERIAL

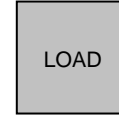

Load machine by placing material underneath Out of Material Rod. Feed material through Centering Roller Guides and adjust rollers to center the material into the entrance of the Feed Belts. Select **LOAD** key and keep it pressed down until the material has been fed completely through the machine. Once the material has exited, release the switch. Machine is now ready to process your material.

FEEB BELT PRESSURE

Turn Feed Belt Pressure Knob **#8449** Clockwise/+ to apply belt pressure or Counter Clockwise /- to release belt pressure. Do not apply excessive belt pressure. Belts only need to be snug to the material.

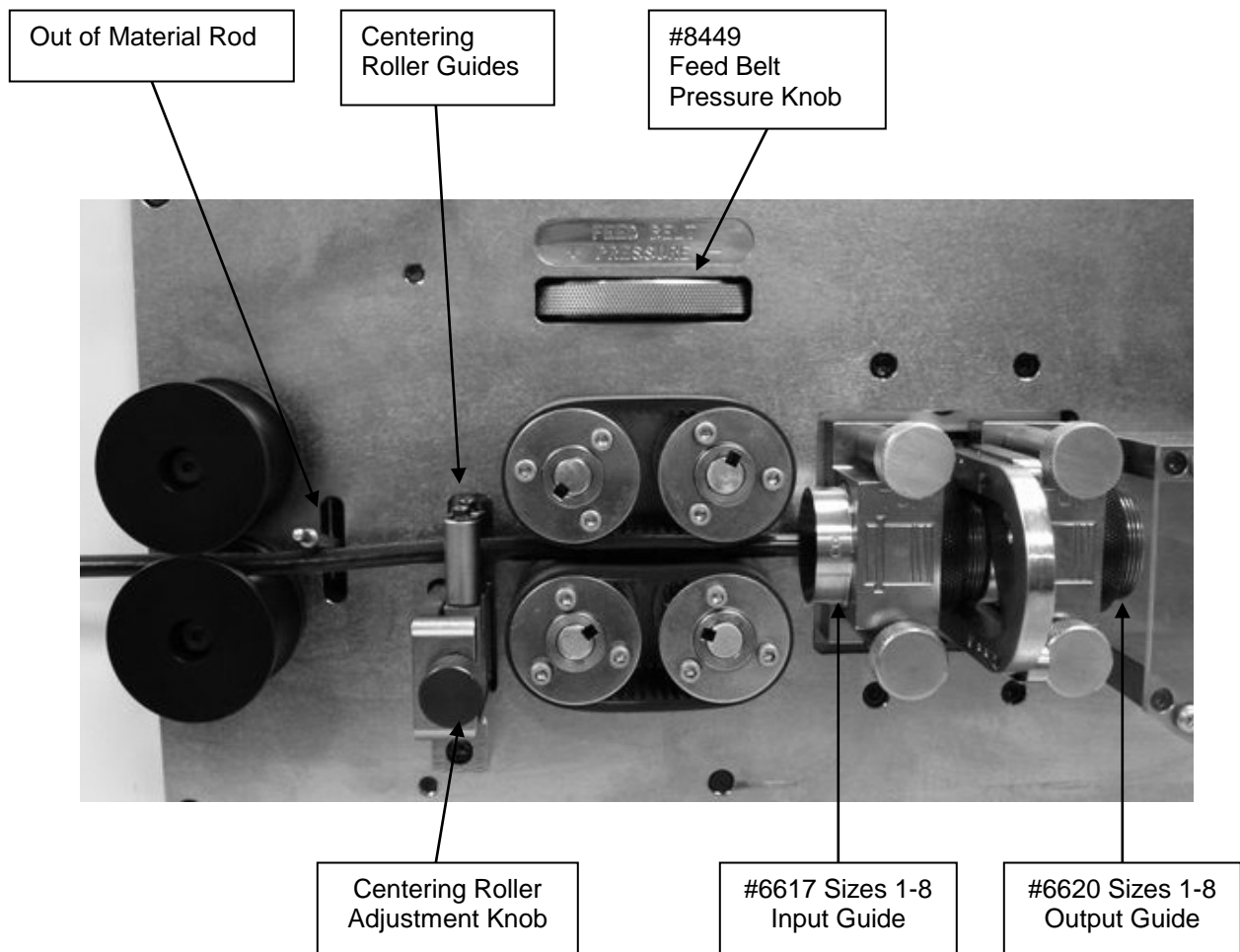

CARPENTER MODEL 36A COMPU-CUT

PROGRAMMING

LCD DISPLAY

SAMPLE DISPLAYS

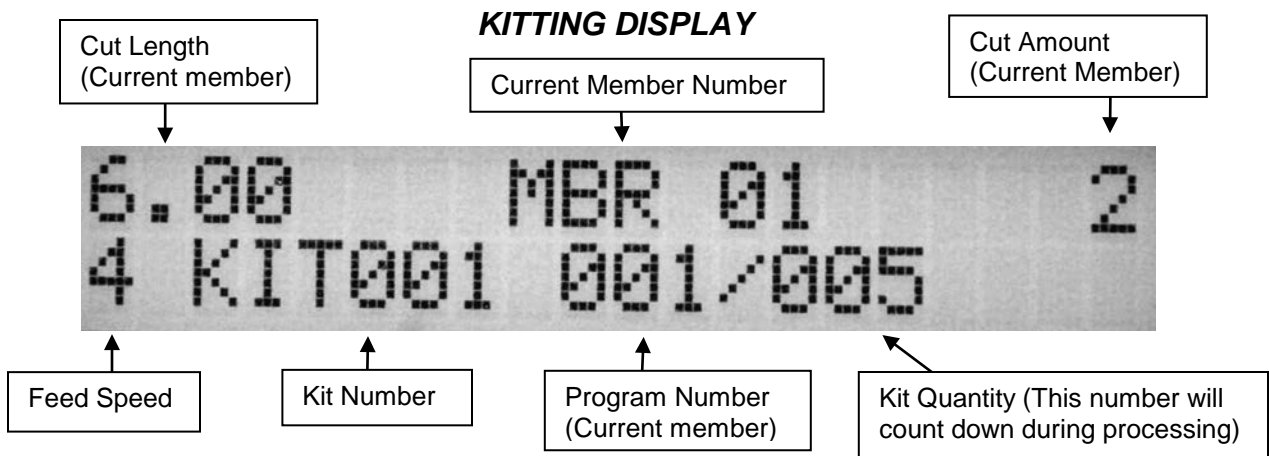
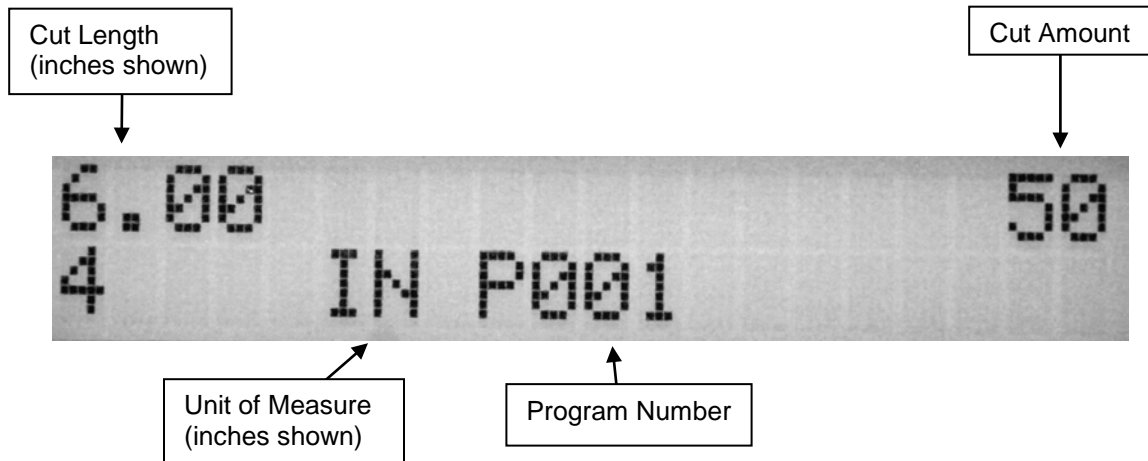
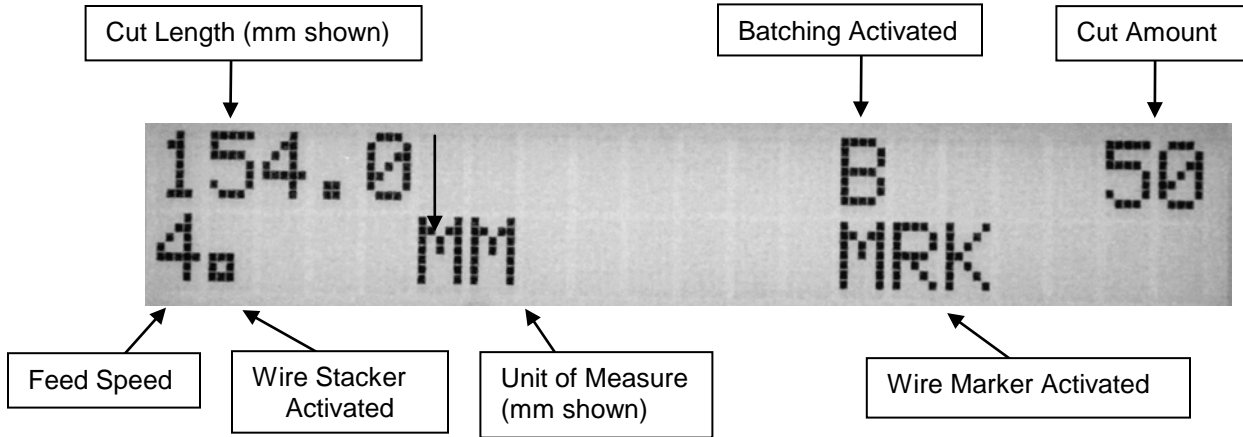

Note: Cut Length, Member Amount & Program Number values relate to current Member number being processed. These values will change as each Member of the Kit is being processed

CARPENTER MODEL 36A COMPU-CUT

PROGRAMMING

cont.

****IMPORTANT****

DO NOT USE SHARP OBJECTS ON KEYBOARD SWITCHES. FINGER TIP PRESSURE IS SUFFICIENT.

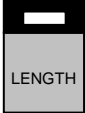
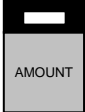
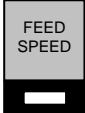
LCD DISPLAY PROMPT	ACTION REQUIRED
COMPU-CUT 36A PLEASE PRESS ENTER	Press ENTER .
	Press LENGTH key. This value is the length of the pieces being processed.
ENTER LENGTH TO CUT	Enter dimension. Press ENTER .
	Press AMOUNT key. This value is the number of pieces to be processed. Also allows access to Multiple Batch Processing mode.
ENTER CURRENT AMOUNT	Enter number of pieces to process. Press ENTER .
BATCHES TO RUN 1	The batch feature allows you to process required pieces in a single or multiple batch(es). The machine will default to one batch. To accept this value Press ENTER . To process total amount in multiple batches, enter number of batches to process (up to 999) using the numerical keypad. Press ENTER .
AMOUNT PER BATCH	This screen will appear only if a number greater than one was entered above. Enter amount of pieces to process per batch. Press ENTER . NOTE: The Batching mode will override the original amount entered, therefore the number of pieces per batch times the number of batches does not need to total the original amount entered.
	Press FEED SPEED key. This value determines the speed of the material passing through the machine
ENTER FEED SPEED FEED SPEED(1-5)=__	Select 1-slow, 2-slow/medium, 3 medium, 4 medium/fast ,5 -fast. Press ENTER .

The Model 36A is now programmed to measure and cut to length your material. You are now ready to run a sample piece and check for initial set up quality. Continue with the following procedures to assist you in processing your sample.

CARPENTER MODEL 36A COMPU-CUT

PROGRAMMING

cont.

SINGLE CYCLE

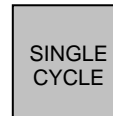

Select **SINGLE CYCLE** key to produce a sample piece to check for accuracy. This feature will cut off the end that is protruding through the blades from the set up then measure and cut a single piece. If corrections are necessary proceed to LENGTH CORRECTION for adjustments.

LENGTH CORRECTION



The Model 36A has a Length Correct feature that allows the operator to make adjustments from the preprogrammed length versus the actual sample length. Small variations are normal due to differences in material, tension, friction, wire diameter etc. If the sample piece was not the correct length select the **LENGTH CORRECT** key for adjustments.

LCD DISPLAY PROMPT

ACTION REQUIRED

ENTER LENGTH CORRECT
CORRECT=_ _

Measure the length of the sample piece produced; enter this value for length. Press **ENTER**. The Model 36A will automatically calculate the correction necessary. The next sample should be the exact length you programmed.

The possible range of correction is +/- 10% of the overall material length. If a value outside of this range is entered an error message will appear. The length correct value may be changed multiple times but typically a single entry is all that is required if the sample piece was measured accurately and the data entered correctly.

RUN PROGRAM

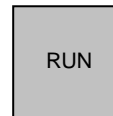

After you have produced a satisfactory sample piece and all settings are correct press **RUN**. This will process your current program.

STOP PROGRAM



If at any time you need to stop your processing press **STOP**.

CARPENTER MODEL 36A COMPU-CUT

PROGRAMMING

cont.

STORING PROGRAMS



The Model 36A will store up to 500 programs. You may access this function by pressing the **MEMORY** key.

LCD DISPLAY PROMPT	ACTION REQUIRED
PRESS 1 TO STORE PRESS 2 TO RECALL	Press 1 on numerical keypad.
--- ENTER PROGRAM NUMBER	Enter up to any 3 digit program number. Press ENTER . The Model 36A will display program # and confirmed stored. Press ENTER . NOTE: If you enter a # already stored the Model 36A will ask you to PRESS 1 TO OVERWRITE OR PRESS CLEAR . Enter 1 to overwrite the previously stored program or press CLEAR to keep the previously stored program. Press ENTER .

RECALLING PROGRAMS

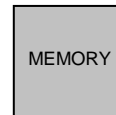

You may access this function by pressing the **MEMORY** key.

LCD DISPLAY PROMPT	ACTION REQUIRED
PRESS 1 TO STORE PRESS 2 TO RECALL	Press 2 on numerical keypad.
PRESS 1 FOR PROGRAM PRESS 2 FOR KIT	Press 1 on numerical keypad.
--- ENTER PROGRAM NUMBER	Enter the 3 digit stored program number. Press ENTER .

NOTE: When recalling a program from memory keep in mind that the values for belt pressure can not be stored. You must always readjust your belt pressure to the material that you are currently processing. If incorrect belt pressure is used, excessive belt wear may occur. If you experience a problem, stored values may need to be changed.

UNLOADING MATERIAL



Unload material by pressing the **UNLOAD** key. Material will automatically feed backwards through machine as long as the switch is depressed.

CARPENTER MODEL 36A COMPU-CUT



SPECIAL FEATURES

To access these features press the **MENU** key. Continue to press the **MENU** key to scroll through the options. To select a feature Press **ENTER** and follow appropriate instructions.

KITTING

The Model 36A is equipped with a **KITTING** feature. This feature allows you to create a **KIT** of different lengths of the same material. A **KIT** can contain up to 20 different items or what we refer to as **MEMBERS**. Each **MEMBER** can be one of 500 previously stored programs. A maximum of 100 **KIT** programs can be stored into the machines memory and recalled at anytime. The kitting feature also allows for an Auto or Manual setting after each kit is completed. The Auto setting will set a time delay between kits to allow the operator to gather the pieces before the next kit starts. The Manual setting will stop at the end of each kit and require the operator to press the **RUN** key to proceed to the next kit. Before programming a kit you will want to have the following information available:

- Determine which previously stored programs you intent to process.
- Determine the amount of pieces to process for each selected program.
- Determine the number of KITS you intent to process.
- Determine if you want the Auto or Manual setting at the end of each KIT.

LCD DISPLAY PROMPT	ACTION REQUIRED
CLEAR SELECTS ON/OFF KITTING: _ _ _	Press CLEAR key to make selection. Press ENTER .
KIT MEMBER NUMBER _ _ PROGRAM NUMBER: _ _ _	A MEMBER is each item within the KIT. The software will assign each MEMBER number as you enter your KIT information. Enter the program number of the first MEMBER of your KIT. Press ENTER .
ENTER AMOUNT _ _	Enter the amount for the first MEMBER of your KIT. Press ENTER .
NUMBER OF KITS TO RUN _ _ _	Enter the number of KITS you want to produce. Press ENTER .
PAUSE MODE: _ _ _ _ _ CLEAR TOGGLES CHOICE	Press CLEAR key to select MANUAL or AUTO. See below for explanation of each setting.

PAUSE MODE: MANUAL

This option will stop the machine at the end of each kit, forcing the operator to push the **RUN** key to proceed to the next KIT.

ENTER RUNS NEXT OR CLEAR TO QUIT	Press ENTER to process the next KIT or Press CLEAR to quit. If you select CLEAR the machine will return to the run screen. To continue with the current KIT program Press RUN or reprogram the machine for a different operation.
---	--

You may stop the processing sequence at anytime by pressing **STOP**, then restart by pressing **RUN**.

CARPENTER MODEL 36A COMPU-CUT

SPECIAL FEATURES

cont.

PAUSE MODE: AUTO

This option lets the operator program a delay time between each kit allowing for time to gather the kit contents before processing the next kit.

LCD DISPLAY PROMPT	ACTION REQUIRED
PAUSE TIME: _ _ _ SEC ENTER PAUSE TIME	Enter pause time between KITS. This can be a maximum of 240 seconds. The machine will pause for the programmed time and then proceed to the next KIT. Press ENTER . Press RUN to beginning processing KITS.

You may stop the processing sequence at anytime by pressing **STOP**, then restart by pressing **RUN**.

STORING KITTING PROGRAMS

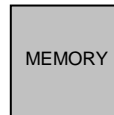

The Model 36A will store up to 100 Kitting programs. You may access this function by pressing the **MEMORY** key.

LCD DISPLAY PROMPT	ACTION REQUIRED
PRESS 1 TO STORE PRESS 2 TO RECALL	Press 1 on numerical keypad.
ENTER KIT NUMBER	Enter up to any 3 digit program number. Press ENTER . The Model 36A will display KIT # and confirmed stored. Press ENTER . NOTE: If you enter a # already stored, the Model 36A will ask you to PRESS 1 TO OVERWRITE OR PRESS CLEAR . Enter 1 to overwrite the previously stored program or press CLEAR to keep the previously stored program. Press ENTER . Press RUN to beginning processing KITS.

CARPENTER MODEL 36A COMPU-CUT

SPECIAL FEATURES

cont.

RECALLING KITTING PROGRAMS

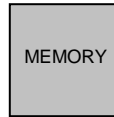

You may access this function by pressing the **MEMORY** key.

LCD DISPLAY PROMPT	ACTION REQUIRED
PRESS 1 TO STORE PRESS 2 TO RECALL	Press 2 on numerical keypad.
PRESS 1 FOR PROGRAM PRESS 2 FOR KIT	Press 2 on numerical keypad.
--- ENTER KIT NUMBER	Enter the 3 digit stored KIT number. Press ENTER .
NUMBER OF KITS TO RUN ---	Enter the number of KITS you want to produce. Press ENTER . Press RUN to beginning processing KITS.

NOTE: When recalling a program from memory keep in mind that the values for belt pressure can not be stored. You must always readjust your belt pressure to the material that you are currently processing. If incorrect belt pressure is used, excessive belt wear may occur. If you experience a problem, stored values may need to be changed.

WIRE MARKING

Factory installed option. See page 17 for program instructions after installation.

UNIT OF MEASURE

The Model 36A can be programmed in either Millimeter or Inches.

LCD DISPLAY PROMPT	ACTION REQUIRED
CLEAR SELECTS UNITS --	Press CLEAR key to select the unit of measure desired. Press ENTER .

CARPENTER MODEL 36A COMPU-CUT

SPECIAL FEATURES

cont.

PASSWORD ON/OFF

The Model 36A comes equipped with a Password feature. When the password is activated the ability to change program data is prohibited.

LCD DISPLAY PROMPT	ACTION REQUIRED
CLEAR SELECTS ON/OFF PASSWORD:	Press CLEAR key to select mode. Note: If you select off menu will clear. Press ENTER .
ENTER PASSWORD	Enter factory set password "123". Press ENTER .

STORE NEW PASSWORD

This option will allow you to change the password at your discretion.

LCD DISPLAY PROMPT	ACTION REQUIRED
ENTER OLD PASSWORD	Enter old password. Press ENTER .
ENTER NEW PASSWORD	Enter desired password number up to 6 digits. Press ENTER .

WIRE STACKER

Factory installed option. See page 19 for program instructions after installation.

MATERIAL SENSOR

The Model 36A comes with an Out of Material sensor. You may find it necessary to turn the sensor off when processing light gauge/weight material that can not support the Out of Material Rod. If the sensor is activated the Model 36A will automatically shut off when it runs out of material. If the sensor is not activated the machine will continue to run and finish the current program until programmed amount reaches zero. You may choose to turn this option on or off.

LCD DISPLAY PROMPT	ACTION REQUIRED
CLEAR SELECTS ON/OFF WIRE SENSOR: _ _ _	Press CLEAR key to select ON or OFF. Press ENTER .

REPRESENTATIVES

Factory use only.

RESERVED

Factory use only.

CARPENTER MODEL 36A COMPU-CUT

OPTIONAL FEATURES

WIRE MARKER

The Model 36A is capable of interfacing with various manufacturers of Hot Stamp Wire Marking units.

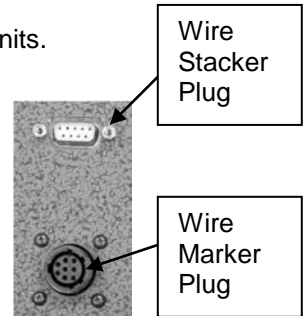

****IMPORTANT****

Please read their operators manual before proceeding.



MACHINE SET UP

- To activate interface between the Model 36A and Wire Marker, install exterior cable between both units. Plug receptacle on Model 36A is located on the back of the cabinet.
- To access Wire Marking program set-up press the **MENU** key until you reach this option. Press **ENTER**.
- After Wire Marking mode is activated **MRK** will appear on the right side of the LCD display.
- All dimensions entered during set-up will correspond with the unit of measure that is programmed into the machine.

LCD DISPLAY PROMPT	ACTION REQUIRED
CLEAR SELECTS ON/OFF WIRE MARKER: ____	Press clear key to select ON or OFF. Press ENTER .
ENTER DWELL TIME __ SECONDS	**Refer to Wire Marker manufacturers operating manual for suggested settings. Enter dwell time using numeric keys. Press ENTER .
ENTER MARKER OFFSET 0.00	With a tape measure, measure the distance from the center of the marking disc to the center of the blades on the Model 36A. Once measurement is made enter that amount using the numeric keys. Press ENTER .
ENTER LEAD END MARK 0.00	This measurement is the distance from the leading end (right end) of the wire to the center of the mark on the wire. Enter distance amount using numeric keys. Maximum distance is (Wire Length/2). Press ENTER .
ENTER TRAIL END MARK 0.00	This measurement is the distance from the trailing end (left end) of the wire to the center of the mark on the wire. Enter distance amount using numeric keys. Maximum distance is ((Wire Length/2) - .20). Press ENTER .
ENTER MARK SPACING 0.00	The Model 36A/Wire Marker system allows you to program continuous marking along the wire in addition to the end marking. To choose this option enter the distance between each marking along the wire. Minimum distance is 0.50" or 0.00"(off). Enter "0" to bypass this option. Press ENTER .
 	Press either key to activate Marker Setup Cycle. At this point the Model 36A and the attached marker will go into a setup cycle. The two units are now automatically synchronized to apply the marks in the locations along the wire as previously programmed.

Process a few sample pieces. Measure the location of the center of the leading end mark from the leading end of wire. If the measured dimension is not equal to the programmed Leading End Mark dimension, proceed to LEADING END MARK DISTANCE CORRECTION.

CARPENTER MODEL 36A COMPU-CUT

OPTIONAL FEATURES

cont.

WIRE MARKER

cont.

LEADING END MARK DISTANCE CORRECTION

BEFORE MAKING ANY LEADING END MARK CORRECTIONS MAKE SURE YOUR OVERALL LENGTH IS CORRECT FIRST; REFER TO PAGE 11, LENGTH CORRECTION.

- The **MEASURED LEAD MARK** screen will not display until after a sample piece has been run using the SINGLE CYCLE or RUN key.
- To access this screen press the MENU key and scroll through to WIRE MARKING. Press **ENTER**.
- Scroll through WIRE MARKING options pressing the ENTER key until the following is displayed, **MEASURED LEAD MARK**.
- Carefully measure from the Leading End of the cut piece to the center of the mark. If the measured dimension is different than the programmed Leading End Mark distance, proceed to instructions below.

LCD DISPLAY PROMPT

ACTION REQUIRED

MEASURE LEAD MARK

Carefully, measure from the Leading End of the cut piece to the center of the Leading End mark. Enter this measured dimension. Press **ENTER**.

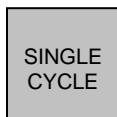
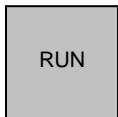

Press either key to activate the Marker Initialization Cycle. When this cycle is complete the marks will have been shifted to their correct locations and normal processing may begin.

NOTES:

A Marker Correction Value can only be entered once. If after running a second test piece you find the Marker Correction Value you entered is incorrect you must clear the previously entered correction value. To clear this value, run the following procedure. Press the Menu key and select Wire Marking. Scroll through the Wire Marking options until you come to the **Measured Lead Mark** screen. Press the **CLEAR** key, then the **ENTER** key. This will reset the correction value back to its original setting. Press the **SINGLE CYCLE** key, this will rerun the Marker Initialization cycle. When completed, press the **SINGLE CYCLE** key again. This will produce a test piece using the original programmed settings. On this test piece, carefully measure the distance from the leading end to the center of the Leading End mark and repeat the LCD Display Prompt Instructions above.

To turn marker option off, press **MENU** and **WIRE MARKER** will appear on screen. Press **CLEAR** key under **OFF** and Press **ENTER**. Marker option is now turned off.

CARPENTER MODEL 36A COMPU-CUT

OPTIONAL FEATURES

cont.

WIRE STACKER

The Model 36A offers the capability to add on a Wire Stacker to collect longer wire lengths. The electrical interface necessary to add this equipment must be purchased separately and installed at the factory.

****IMPORTANT****

Please read their operators manual before proceeding.

MACHINE SET-UP

- To activate interface between the Model 36A and Wire Stacker, install exterior cable between both units. Plug receptacle on Model 36A is located on the back of the cabinet.
- To access Wire Stacking program set-up press the **MENU** key.
- After Wire Stacking mode is activated a small square will appear on the lower left side of the LCD display.
- All dimensions entered during set-up will correspond with the unit of measure that is programmed into the machine.

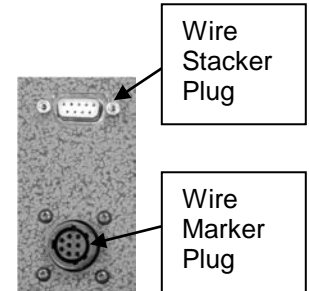

LCD DISPLAY PROMPT	ACTION REQUIRED
WIRE STACKER	Press ENTER .
CLEAR SELECTS ON/OFF WIRE STACKER:	Press CLEAR key to select ON. Press ENTER .
STACKER DWELL TIME 0.00 SECONDS	Enter the Stacker dwell time. This time is determined by the time it takes the Stacker to complete its cycle for the current wire being processed. The dwell time range is from 0 to 2.50 seconds. Enter selected time and press ENTER .

CARPENTER MODEL 36A COMPU-CUT

MAINTENANCE PROCEDURES

BELT CHANGE OR REMOVAL

1. Turn machine off and unplug from electrical and air supply.
2. Separate belts via the **#8449** Belt Pressure Adjustment Knob.
3. Remove **#5451** Screws, **#8525** Washers and **#8514** Belt Guides.
Then remove **#6627** Feed Belts.
Reverse procedure to reinstall.

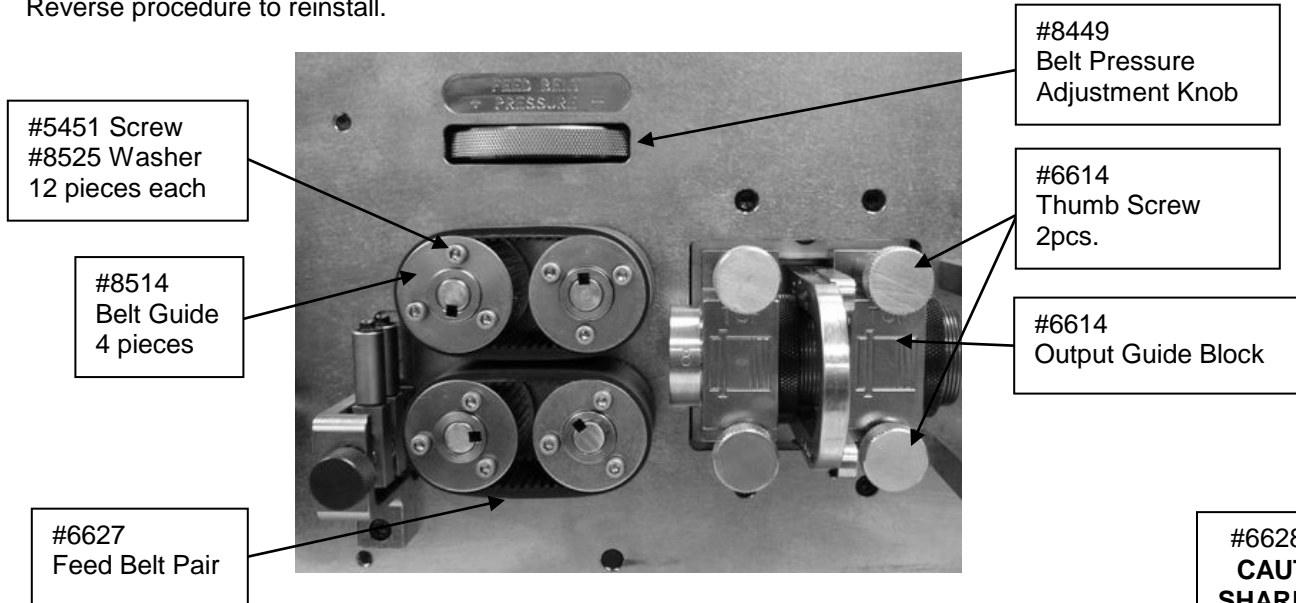

BLADE CHANGE

1. Turn machine off and unplug from electrical and air supply.
2. Remove 2pcs. **#6614** Thumb Screws from **#6614** Output Guide Block.
NOTE: Remove ONLY Output Guide Block.
3. Use **#8436** 7/64" Hex Wrench to loosen 4pcs. **#3823** Screw.
NOTE: Only loosen the screws, do not remove.
4. Swing **#6606** Top Blade Holder up as per diagram.
5. Remove **#6628** Blade. ****CAUTION** BLADE EDGE IS VERY SHARP**
6. Brush all components clean using a soft bristle brush.
7. Install new blade as per diagram. Set bottom edge point in between dowel pins. Set top edge between dowel pins.
8. Swing **#6606** Top Blade Holder down and retighten 4pcs. **#3823** Screw.
9. Reconnect electrical and air supply. Close lexan Safety Guard.
10. Turn machine on at main power switch. Press **ENTER** key, then press **WIRE GUIDE** key. This will position blade for Guide Block reinstall.
11. Reinstall Output Guide Block making sure to push the Output Guide up to the blade. Tighten into place with 2pcs. **#6614** Thumb Screw.
12. Press **ENTER** key to return to the main run screen. Blade change is now complete.

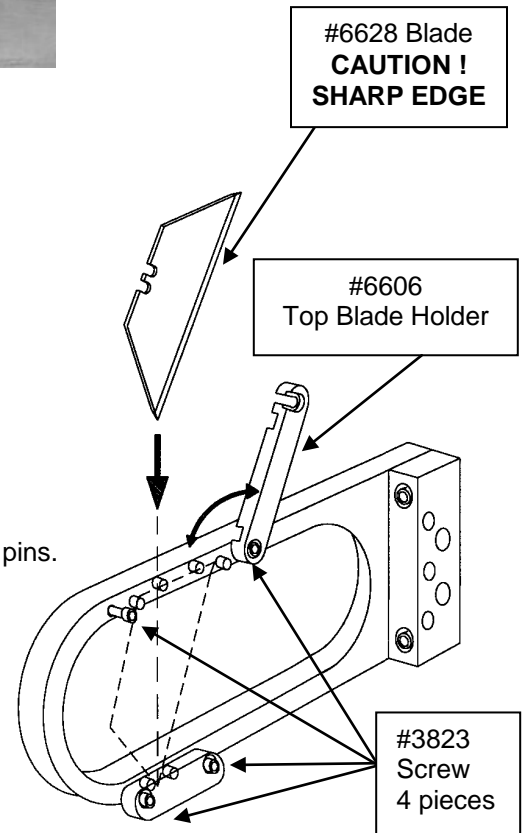

CARPENTER MODEL 36A COMPU-CUT

MAINTENANCE PROCEDURES

cont.

MACHINE LUBRICATION

It is very important to lubricate the Pneumatic Cylinder that operates the Blade Mechanism. This is done by using an automatic inline oiler filled with standard pneumatic tool oil. The automatic inline oiler should be set so the Model 36A receives approximately 1 drop of pneumatic tool oil every 10-12 minutes of continuous cutting at 80 PSI. Operating the machine without an oiler may result in damage to the cylinder.

Above system is available for purchase from the factory. Please refer to Page 23 for ordering information.

CARPENTER MODEL 36A COMPU-CUT

TROUBLE SHOOTING

KEY ELEMENTS FOR TROUBLE FREE OPERATION

Make certain:

- Unit is plugged into a proper electrical outlet.
- Air line is connected properly to machine and air source.
- Unit is turned on.
- Feed Belt tension is adjusted properly.
- Data entered is correct and accurate.
- Prefeed is being used if required.

COMMON PROBLEMS

SOLUTIONS

Display reads: *** BLADE ERROR *** PLEASE PRESS ENTER	<ol style="list-style-type: none">1. Material exceeds cutting limits of machine.2. Air pressure too low.3. Air line not attached properly.
Length Inaccuracies	<ol style="list-style-type: none">1. Check Wire Guide clearance.2. Check Feed Speed3. Check Feed Belt pressure.4. Verify length setting.5. Motorized Prefeed required?
Material Jams	<ol style="list-style-type: none">1. Check Wire Guide clearance.2. Check Feed Belt pressure.3. Check Feed Speed.4. Check for possible material splice.5. Check for foreign material / debris.
Material not tracking straight through the Feed Belts	<ol style="list-style-type: none">1. Check Feed Belt Pressure.
Cuts are not square	<ol style="list-style-type: none">1. Check Wire Guide Clearance.2. Check material for excessive memory.

CARPENTER MODEL 36A COMPU-CUT

RECOMMENDED SPARE PARTS

1pr. **#6627** Feed Belt Pair

1ea. **#6628** Blade Pack (5pcs.)

OPTIONAL EQUIPMENT

#8520 Wire Marker/Wire Stacker Electronic Interface - Factory Installed

#6551 Regulator/Filter/Oiler Assembly

#6650 Complete Input/Output Guide Set

#8925 Emergency Stop Switch Assembly

CARPENTER MODEL 36A COMPU-CUT

WARRANTY

Carpenter Mfg. Co., Inc. manufactures its products to be free from defects in materials and workmanship. Should any defect occur within 1 year after shipment, Carpenter Mfg. Co., Inc. will at its option, exchange or repair the defective device.

Repairs or adjustments to equipment under warranty can be performed at our factory or at the customer location, at the option of Carpenter Mfg. Co., Inc. In most cases a 1-2 day turn around time will be necessary to repair equipment at our facility. When equipment is returned to our factory for repair or replacement, freight charges will be borne by the customer. Repaired or replaced equipment will be returned at Carpenter's expense via U.P.S. ground service. If alternate shipping is requested by the customer, the difference in shipping charges will be billed to the customer.

This is a limited warranty and is in lieu of all other representations and expressed and implied warranties (including the implied warranties of merchantability and fitness for use.) Under no circumstances shall Carpenter Mfg. Co., Inc. be liable for any incidental or consequential property damages or losses subsequent to misuse or improper maintenance of this equipment.

Not covered by this warranty are:

- Consumable parts (blades, belts, guides, springs, inserts, stripping wheels, etc.)
- Cosmetic problems (nicks, scratches, etc.)
- Damages caused by any repairs or modifications by unauthorized personnel
- Abuse
- Damage caused by shipping
- Damage caused by environmental and/or atmospheric conditions.
- Damage caused by the use of contaminated compressed air.